

1 2 3 4 5 6

A

B

C

D

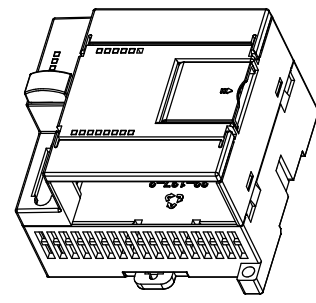
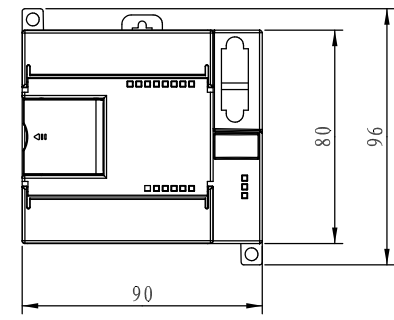
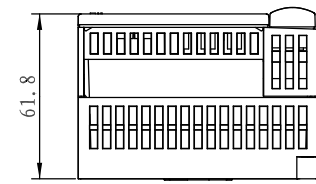
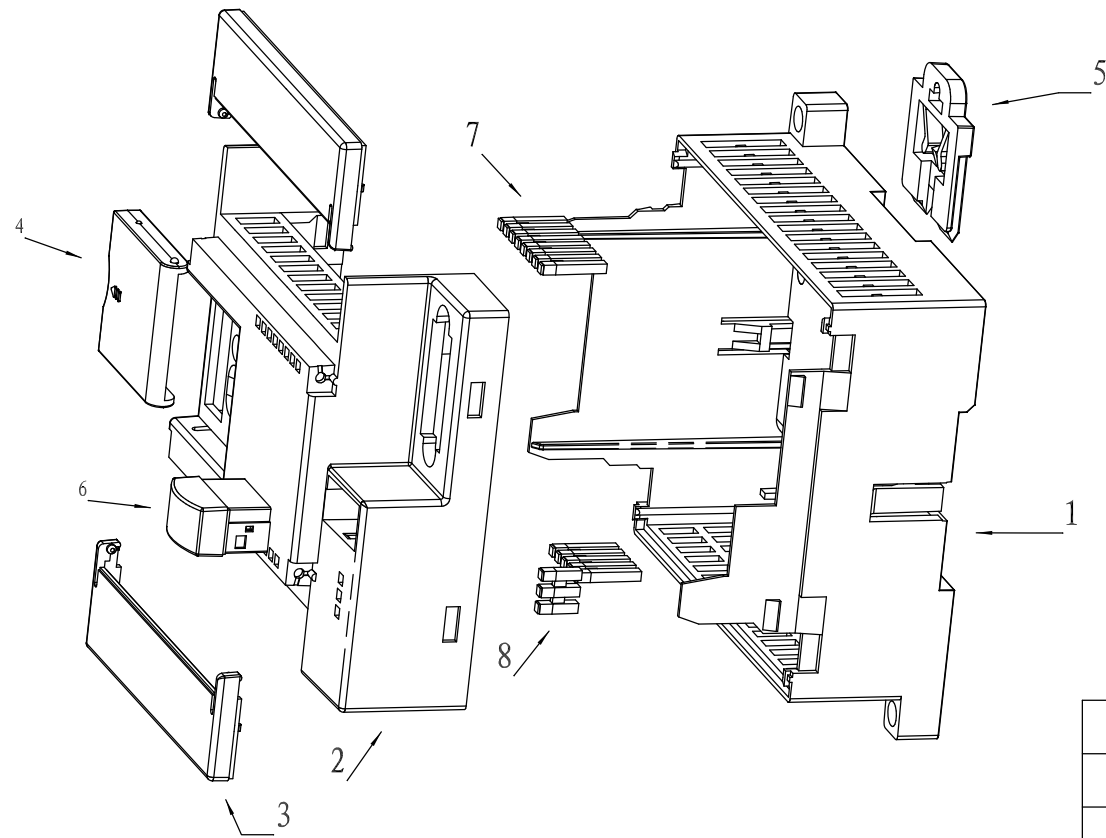

8	22-137-8	导光柱2	1	PC		
7	22-137-7	导光柱1	2	PC		其中一个去除两个光柱
6	22-137-6	方盖	1	阻燃ABS		
5	22-137-5	卡簧	1	聚甲醛POM		
4	22-137-4	翻盖	1	阻燃ABS		
3	22-137-3	长翻盖	2	阻燃ABS		
2	22-137-2	底盖	1	阻燃ABS		
1	22-137-1	上盖	1	阻燃ABS		
<u>序号</u> Number	<u>产品编号</u> Product Code	<u>零件名称</u> Part Name	<u>数量</u> Quantity	<u>材料</u> Material	<u>重量(g)</u> Weight	<u>备注</u> Remarks
<u>制图</u> Drawing	<u>审核</u> Auditing	<u>批准</u> Confirm	<u>客户名称</u> Custom Name	<u>材料</u> Material	<u>备注</u> Remarks	
			<u>产品名称</u> Product Name	装配图	<u>图纸比例</u> Drawing Scale	1:1 A
			<u>产品编号</u> Product Code	22-137	<u>视图</u> Project View	(mm)
共 页 第 页			宁波三和壳体公司 NINGBO SANHE ENCLOSURE CORPORATION		中国·宁波慈溪 TEL:+86(574)63226910 FAX:+86(574)63226900	

1 2 3 4 5 6

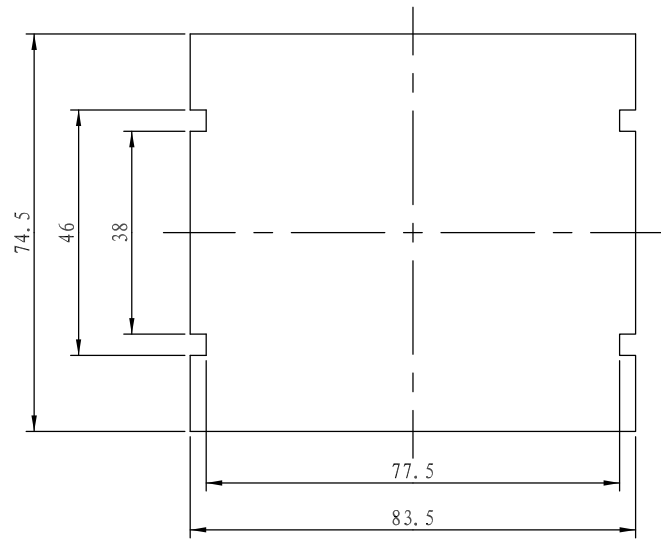

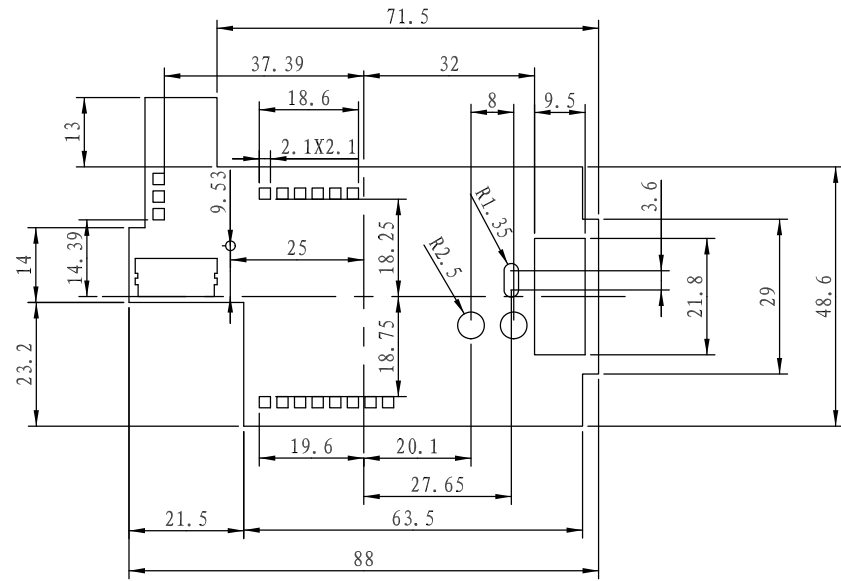

底线路板

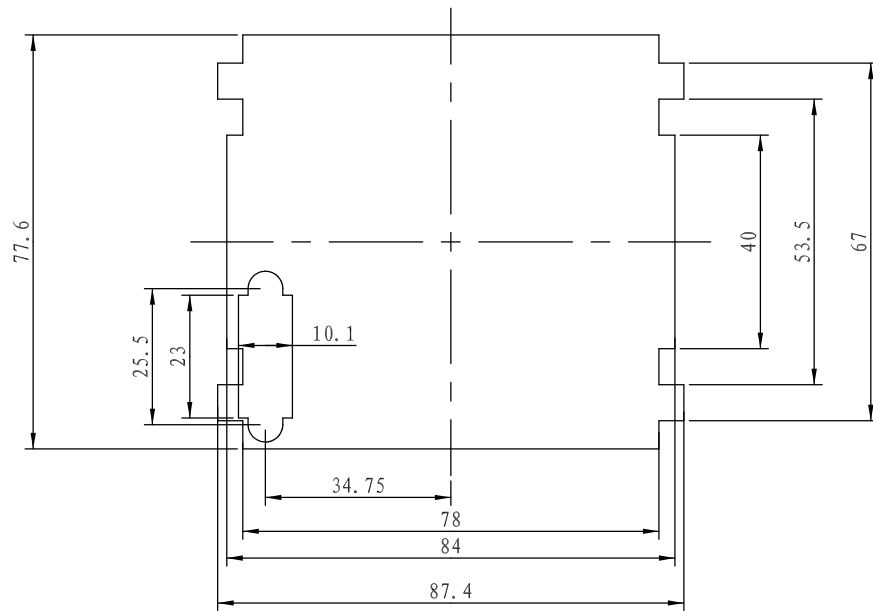

上线路板

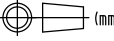

中线路板

制图 Drawing	审核 Auditing	批准 Confirm	客户名称 Custom Name	材料 Material		
			产品名称 Product Name	图纸比例 Drawing Scale	A3	
			产品编号 Product Code	视图 Project View	 (mm)	
共 页 第 页			 宁波三和壳体公司 NINGBO SANHE ENCLOSURE CORPORATION		中国宁波慈溪 TEL:+86(574)63226910 FAX:+86(574)63226900	