

比例 1:1

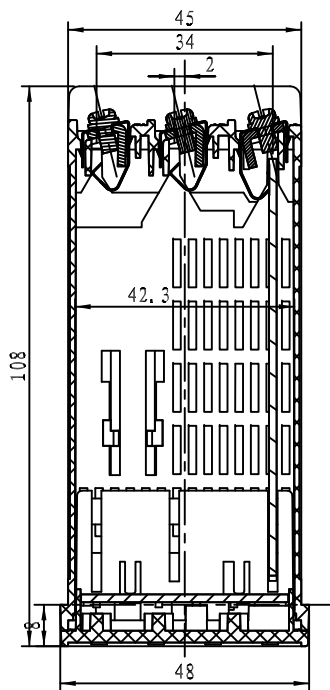

截面 A-A

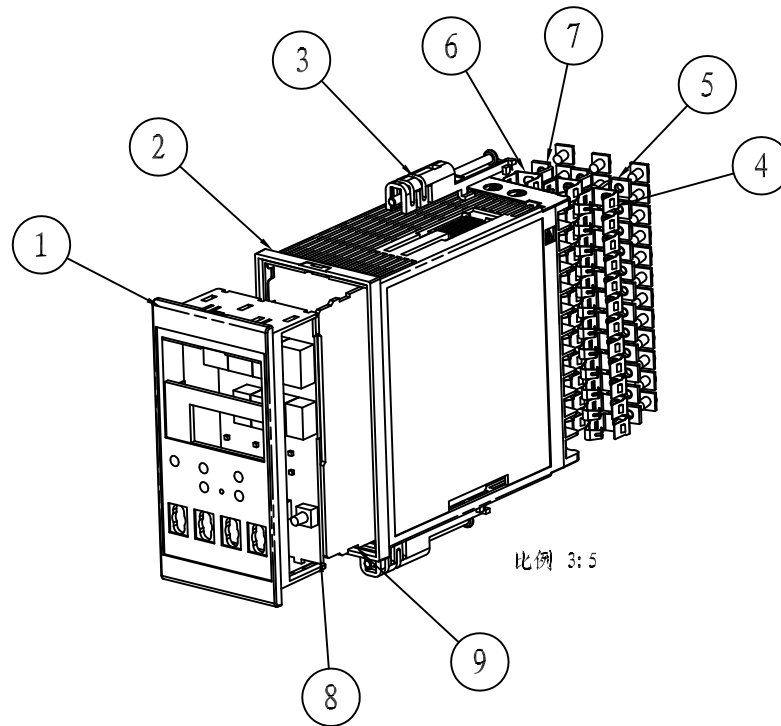

比例 3:5

序号	编号	名称	数量	材料	单重 (g)	备注
9	4988-XLB2	线路板	1			
8	4988-XLB1	线路板	1			
7	4874-7	内铁片	24	铁皮 (1.5MM)		
6	4874-6	弹片	24	磷铜 (0.25MM)		M3*6 (36个) 组合螺丝6*6
5	4874-5	内铁片	12	铁皮 (1.5MM)		
4	4874-4	弹片	12	磷铜 (0.25MM)		
3	4988-3	安装架	2	普通ABS		M3*50螺杆和 M3六角螺母
2	4988-2	壳体	1	普通ABS		
1	4988-1	面框	1	普通ABS		

制图	审核	批准	客户名称	材料		
Drawing	Auditing	Confirm	Custom Name	Material	图纸比例	
			产品名称	装配示意图	1:1	A3
			产品编号	4988	视图	
			Product Code		Project View	
共 1 页		第 1 页		宁波三和壳体公司 NINGBO SANHE ENCLOSURE CORPORATION		中国宁波慈溪 TEL: +86(574)63226910 FAX: +86(574)63226900

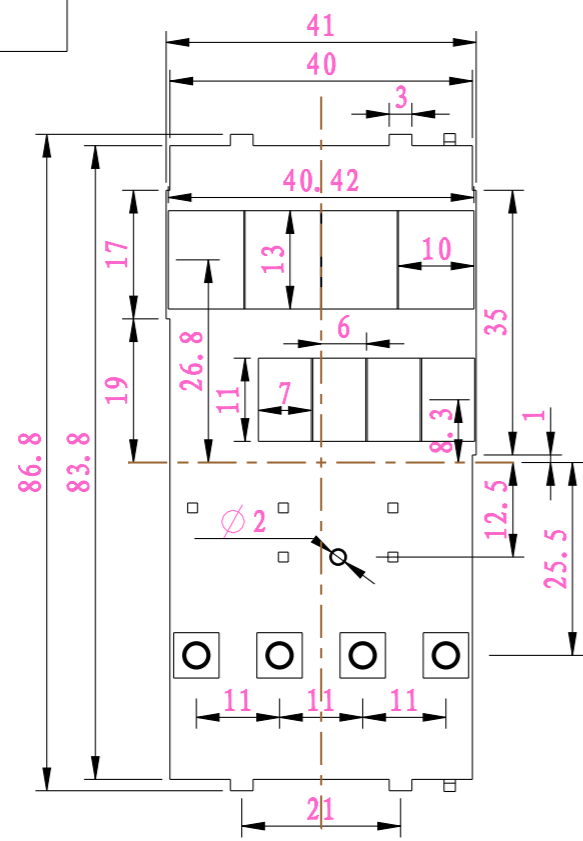

比例 1:1

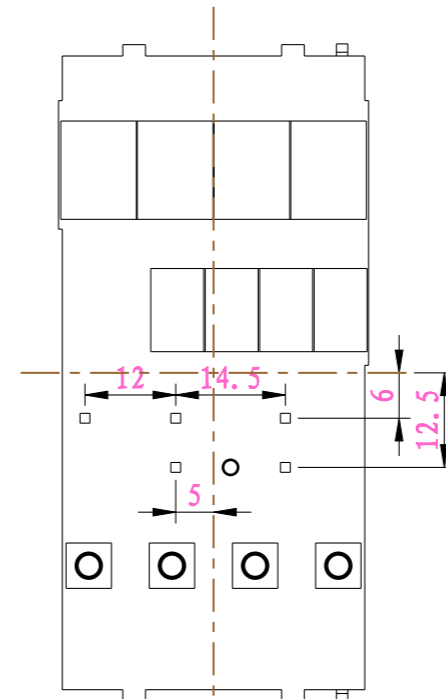
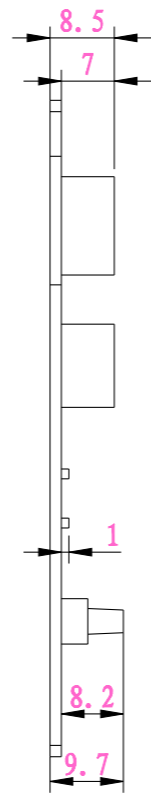

比例 1:1

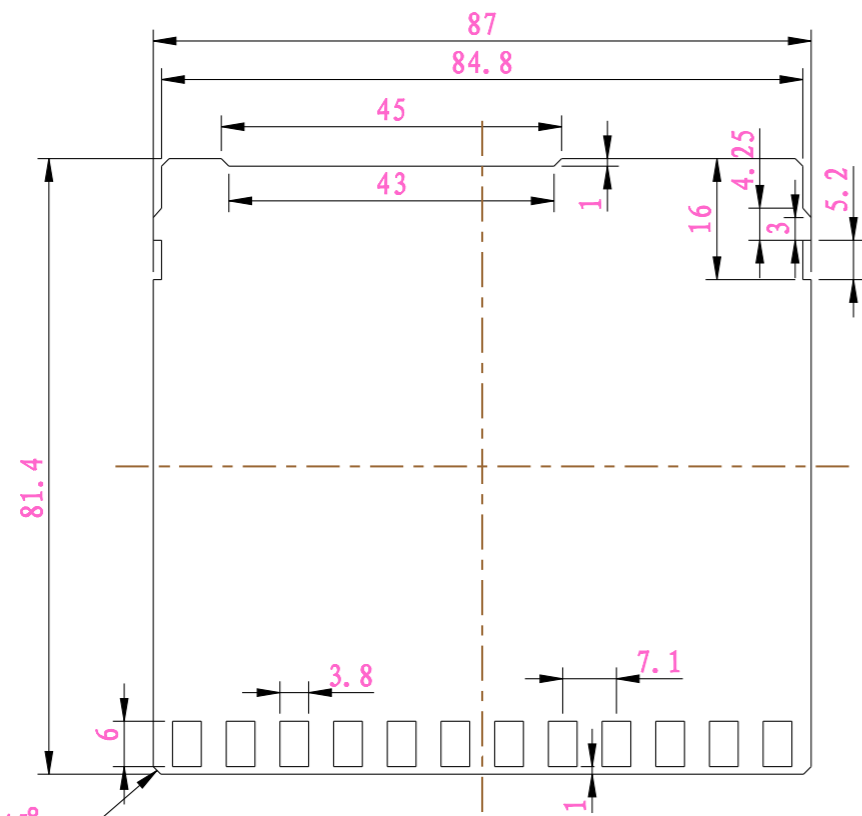

比例 1:1

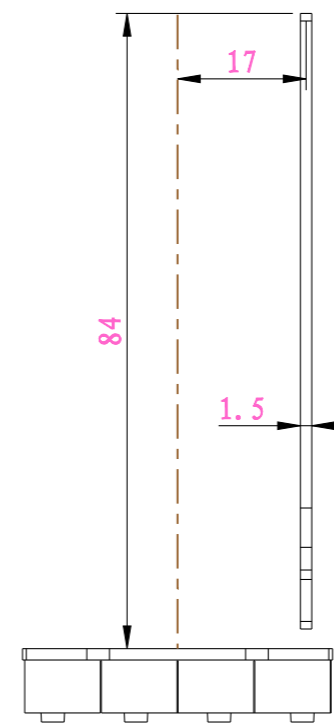
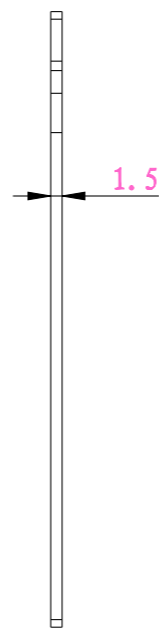

比例 1:1

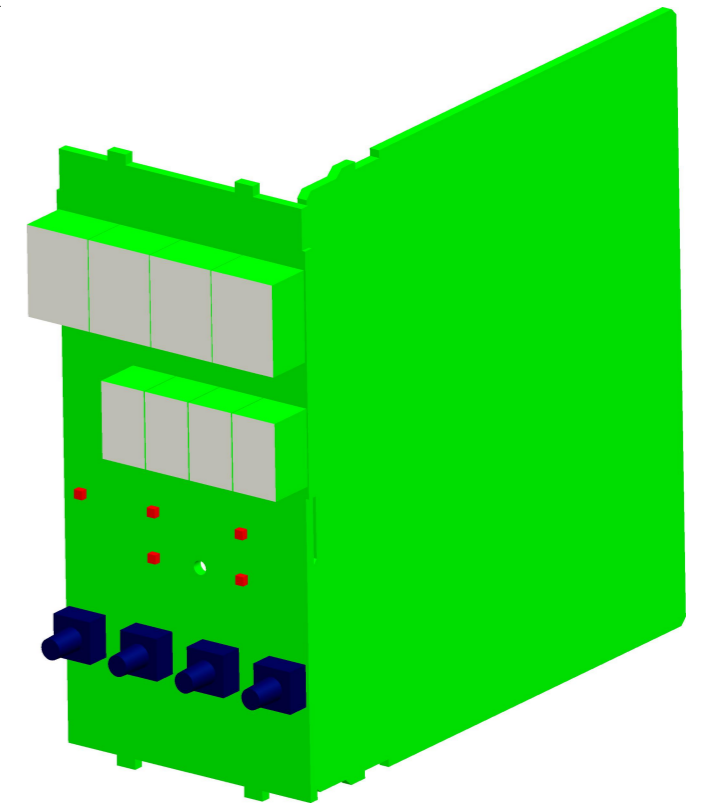

制图 Drawing	审核 Auditing	批准 Confirm	客户名称 Custom Name	本厂开发	材料 Material	
胡鑫波			产品名称 Product Name	线路板	图纸比例 Drawing Scale	1:1 A3
11-07-02			产品编号 Product Code	4988-XLB	视图 Project View	(mm)
共 1 页 第 1 页			宁波三和壳体公司 NINGBO SANHE ENCLOSURE CORPORATION		中国宁波慈溪 TEL: +86(574)63226910 FAX: +86(574)63226900	